

Spiral 1 / Unit 6

Flip-flops and Registers

© Mark Redekopp

Outcomes

- I know the difference between combinational and sequential logic and can name examples of each.
- I understand latency, throughput, and at least 1 technique to improve throughput
- I can identify when I need state vs. a purely combinational function
 - I can convert a simple word problem to a logic function (TT or canonical form) or state diagram
- I can use Karnaugh maps to synthesize combinational functions with several outputs
- I understand how a register with an enable functions & is built
- I can design a working state machine given a state diagram
- I can implement small logic functions with complex CMOS gates

FLIP FLOPS AND REGISTERS

Flip-Flops

- Outputs only change once per clock period
 - Outputs change on either the *positive edges* of the clock or the *negative edges*

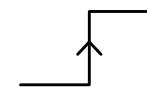

Positive-Edge of the Clock

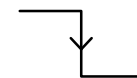

Negative-Edge of the Clock

Flip-Flops

- To indicate negative-edge triggered use a bubble in front of the clock input

Positive-Edge Triggered D-FF

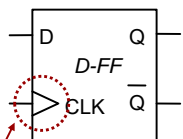

No bubble indicates positive-edge triggered

Negative-Edge Triggered D-FF

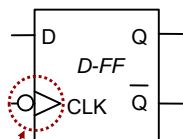

Bubble indicates negative-edge triggered

Positive-Edge Triggered D-FF

- Q looks at D only at the positive-edge

CLK	D	Q*	Q**
0	x	Q	Q'
1	x	Q	Q'
↑	0	0	1
↑	1	1	0

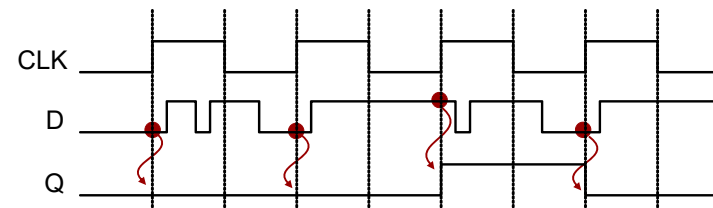

Q only samples D at the positive edges and then holds that value until the next edge

Negative-Edge Triggered D-FF

- Q looks at D only at the negative-edge

CLK	D	Q*	Q**
0	x	Q	Q'
1	x	Q	Q'
↓	0	0	1
↓	1	1	0

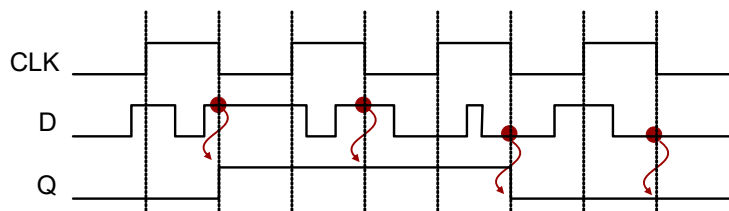

Q only samples D at the negative edges and then holds that value until the next edge

D FF Example

- Assume positive edge-triggered FF

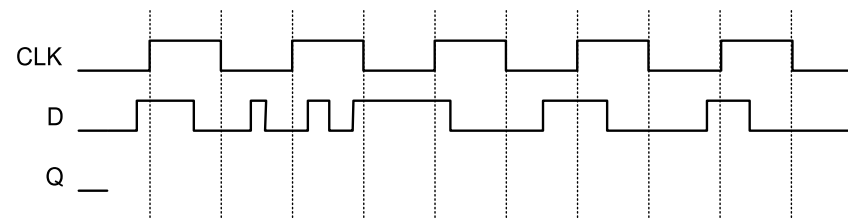

D FF Example

- Assume negative edge-triggered FF

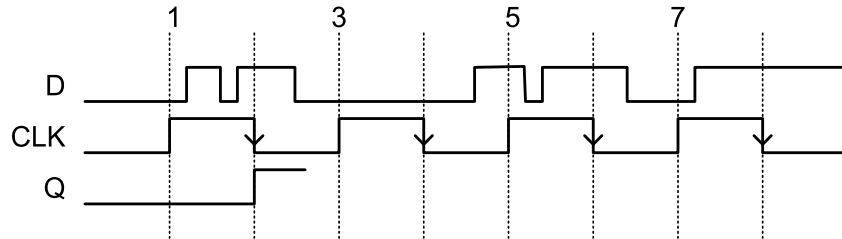

Shift Register

- A shift register is a device that acts as a 'queue' or 'FIFO' (First-in, First-Out).
- It can store n bits and each bit moves one step forward each clock cycle
 - One bit comes in the overall input per clock
 - One bit 'falls out' the output per clock



Shift Register

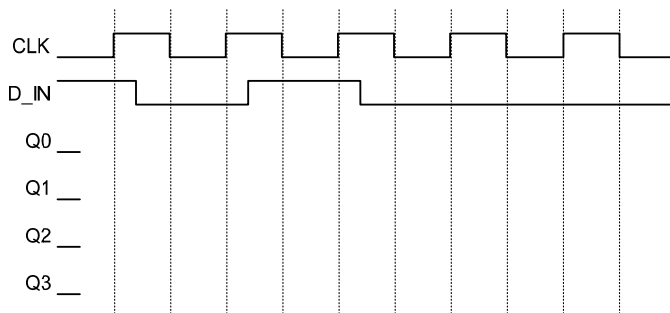
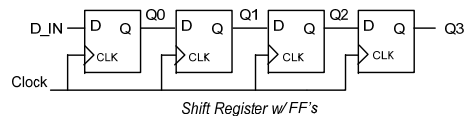

INITIALIZING OUTPUTS

Initializing Outputs

- Need to be able to initialize Q to a known value (0 or 1)
- FF inputs are often connected to logic that will produce values after initialization
- Two extra inputs are often included: PRESET and CLEAR

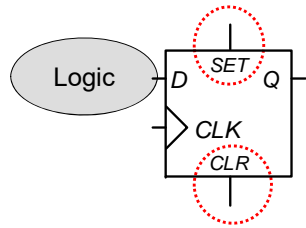

When CLEAR = active
Q* = ___
When SET = active
Q* = ___
When NEITHER = active
Normal FF operation

Note: SET and CLR have priority over normal FF inputs

Initializing Outputs

- To help us initialize our FF's use a RESET signal
 - Generally produced for us and given along with CLK
- It starts at *Active (1)* when power turns on and then goes to *Inactive (0)* for the rest of time
- When it's active use it to initialize the FF's and then it will go inactive for the rest of time and the FF's will work based on their inputs

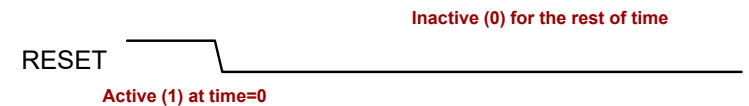

Initializing Outputs

- Need to be able to initialize Q to a known value (0 or 1)

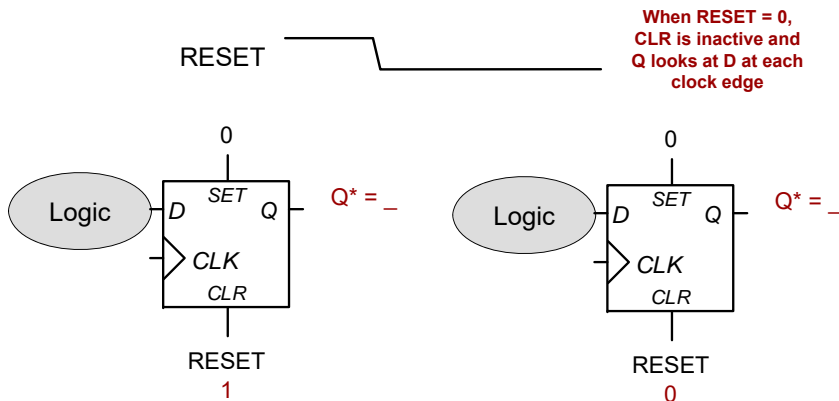

When RESET = 0,
CLR is inactive and
Q looks at D at each
clock edge

Implementing an Initial State

- When RESET is activated Q's initialize to 0 and then when it goes back to 1 the Q's look at the D inputs

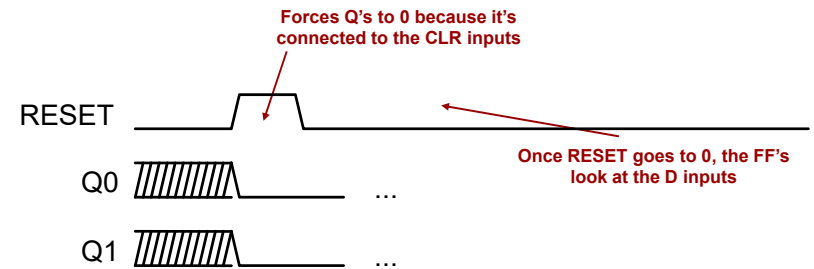

Forces Q's to 0 because it's
connected to the CLR inputs

Once RESET goes to 0, the FF's
look at the D inputs

Preset / Clear Example

- Assume an **synchronous** Preset

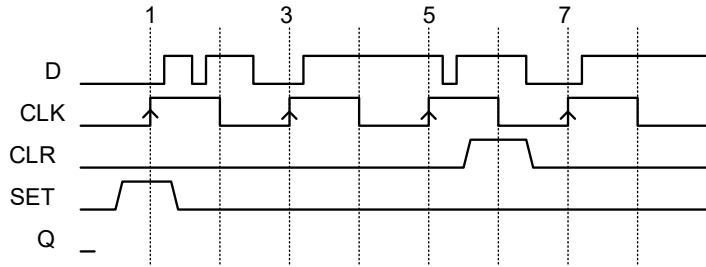

Using muxes to control when register save data

REGISTER WITH ENABLES

Register Resets/Clears

- When the power turns on the bit stored in a flip-flop will initialize to a _____ value
- Better to initialize it to a known value (_____)
- Use a special signal called " _____ " to force the flip-flops to 0's

CLK	RST	D _i	Q _i *
1,0	X	X	Q _i
↑			
↑			
↑			

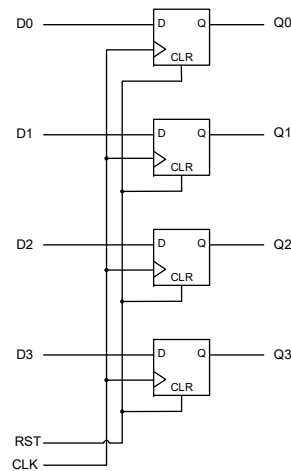

4-bit Register

Register Problem

- Whatever the D value is at the clock edge is sampled and passed to the Q output until the next clock edge
- Problem: Register will save data on _____ edge
 - Often we want the ability to save on one edge and then _____ that value for many more cycles

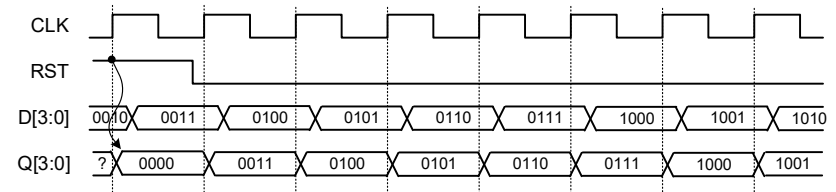

4-bit Register – On clock edge, D is passed to Q

Solution

- Registers (D-FF's) will sample the D bit every clock edge and pass it to Q
- Sometimes we may want to hold the value of Q and ignore D even at a clock edge
- We can add an enable input and some logic in front of the D-FF to accomplish this

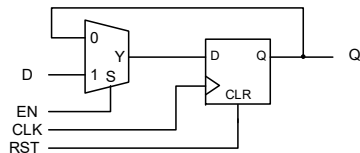

FF with Data Enable
(Always clocks, but selectively chooses old value, Q, or new value D)

CLK	RST	EN	D _i	Q _i *
0,1	X	X	X	Q _i
↑	1	X	X	0
↑				
↑				
↑				

Registers w/ Enables

- When EN=0, Q value is passed back to the input and thus Q will maintain its value at the next clock edge
- When EN=1, D value is passed to the input and thus Q will change at the edge based on D

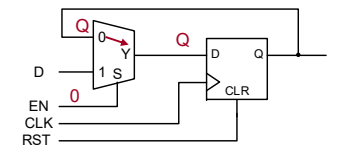

When EN=0, Q is recycled back to the input

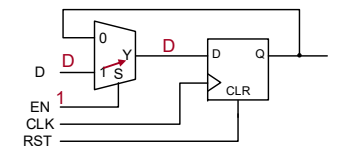

When EN=1, D input is passed to FF input

4-bit Register w/ Data (Load) Enable

- Registers (D-FF's) will sample the D bit every clock edge and pass it to Q
- Sometimes we may want to hold the value of Q and ignore D even at a clock edge
- We can add an enable input and some logic in front of the D-FF to accomplish this

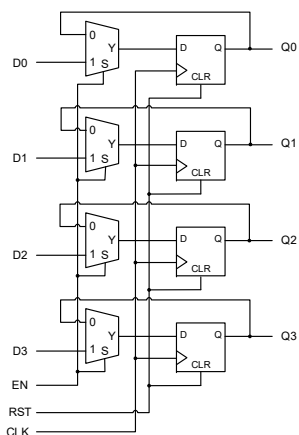

4-bit register with 4-bit wide 2-to-1 mux in front of the D inputs

CLK	RST	EN	D _i	Q _i *
0,1	X	X	X	Q _i
↑	1	X	X	0
↑	0	0	X	Q _i
↑	0	1	0	0
↑	0	1	1	1

Registers w/ Enables

- The D value is sampled at the clock edge only if the enable is active
- Otherwise the current Q value is maintained

